



Automotive H-Bridge Driver

- Operating Supply Voltage 5V to 28V
- Overvoltage Protection against Transients up to 40V at Vbat
- $R_{DSon} = 150m\Omega$ for each Output Transistor at 25°C
- Continuous DC Load Current 5A ($T_C < 100^\circ C$)
- Output Current Limitation at typ 6,5A +/- 20%
- Short-Circuit Shutdown for Output Currents over 8A
- Logic Inputs TTL/CMOS Compatible
- Operating Frequency up to 20 kHz
- Overtemperature Protection
- Short-Circuit Protection
- Undervoltage Disable Function
- Diagnostic Output
- 2 Disable Inputs
- Coding Input for Alternative Functions
- HSOP20 Power Package
- Stable Operation with an External Capacitance of maximum 47 μ F at Vbat

MC33186

H-BRIDGE DRIVER

SEMICONDUCTOR TECHNICAL DATA



DH1 SUFFIX
PLASTIC PACKAGE
CASE 751A-03
HSOP-20

PIN CONNECTIONS

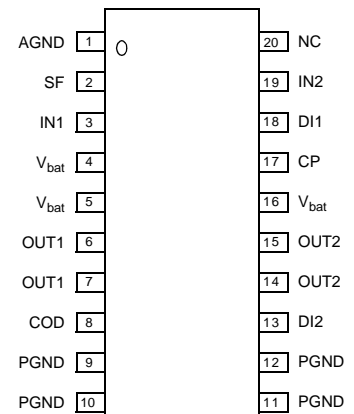

Metal slug is connected to power ground

(Top View)

Simplified Block Diagram

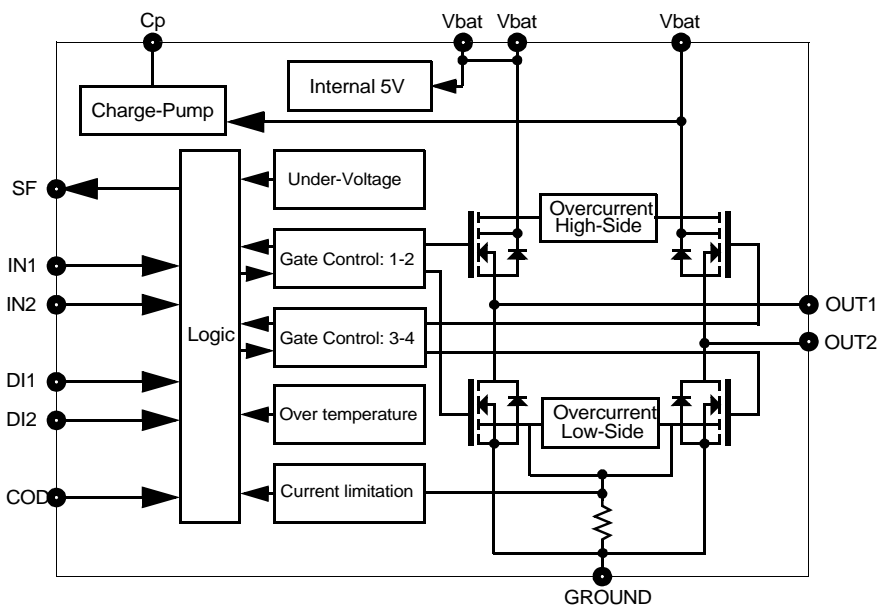

ORDERING INFORMATION

Device	Temperature Range	Package
MC33186DH1R2	-40°C to +125°C	HSOP20

MAXIMUM RATINGS

Ratings	Symbol	Min	Typ	Max	Unit
---------	--------	-----	-----	-----	------

ELECTRICAL RATINGS

Supply Voltage - Static Destruction Proof - Dynamic Destruction Proof $t < 0,5s$	Vbat Vbat	- 1 - 2		28 40	V
Logic Inputs (IN1, IN2, DI1, DI2, CODE)	U	- 0.5		7	V
Output Status - Flag SF	U _{SF}	- 0.5		7	V

THERMAL RATINGS

Junction Temperature	T _j	- 40		+150	°C
Storage Temperature	T _s	- 55		+125	°C
Ambient Temperature	T _a	- 40		+125	°C
Thermal Resistance (with power applied on 2 power MOS)	Rth _{JC}			+1,5	K/W

ELECTRICAL CHARACTERISTICS. T_j : from -40°C to +150 °C, Vbat from 5 V to 28 V, unless otherwise note. Typical values reflect approximate mean at 25°C, nominal VCC, at time of device characterization.

Characteristics	Symbol	Min	Typ	Max	Unit
-----------------	--------	-----	-----	-----	------

RANGE OF VALIDITY

	Vbat T _j	5 -40		28 150	V °C
--	------------------------	----------	--	-----------	---------

POWER SUPPLY

Operating Range : - Static - Dynamic (t < 500ms)	Vbat Vbat	5		28 40	V V
Stanby current - f = 0 to 10KHz ; I _{OUT} = 0A	I Vbat			35	mA
Vbat-undervoltage switch-off (without load) - Switch-off Voltage - Switch-on Voltage - Hysteresis		4.15 4.5 150	4.4 4.75	4.65 5	V V mV

CHARGE-PUMP SUPPLY

- Vbat = 4.15 V - Vbat < 40V	Vcp - Vbat Vcp - Vbat	3.35		20	V V
---------------------------------	--------------------------	------	--	----	--------

LOGIC INPUTS

Input High	VinH	3.4			V
Input Low	VinL			1.4	V
Input Hysteresis	U	0.7	1		V
Input Current (IN1, IN2, DI1) - U _{IN} = 0V	I	- 200	- 80		μA
Input Current (DI2,COD) - U _{DI2} = 5V	I _{DI2}		25	100	μA

ELECTRICAL CHARACTERISTICS. T_j : from -40°C to $+150^{\circ}\text{C}$, V_{bat} from 5 V to 28 V, unless otherwise note. Typical values reflect approximate mean at 25°C , nominal VCC, at time of device characterization.

Characteristics	Symbol	Min	Typ	Max	Unit
-----------------	--------	-----	-----	-----	------

POWER OUTPUTS : OUT1, OUT2

Switch on resistances : $R_{\text{OUT}} - V_{\text{bat}}$; $R_{\text{OUT}} - \text{GND}$ - $V_{\text{bat}} = 5$ to 28V ; $C_{\text{cp}} = 0$ to 33nF				300	$\text{m}\Omega$
Current Limitation Controlled Peak Value					
Switch-off Current	$(I_{\text{OUT}})_{\text{max}}$	5.2	6.5	7.8	A
Switch-off Time	t_a	15	20.5	26	μs
Blanking Time	t_b	12	16.5	21	μs
High Side Overcurrent Detection Low Side Overcurrent Detection (4)	I_{OCHS} I_{OCLS}	11 8			A A
Leackage Current - Output Stage Switched off				100	μA
Free-Wheeling Diode Forward Voltage - $I_{\text{OU}} = 3\text{A}$	U_D			2	V
Free-Wheeling Diode Reverse Recovery Time	t_{rr}	100			ns
- Switch-off Temperature - Hysteresis		160 20		190 30	$^{\circ}\text{C}$ $^{\circ}\text{C}$

OUTPUT STATUS FLAG (Open drain output)

Output High (SF not set) $U_{\text{SF}} = 5\text{V}$	I_{SF}			10	μA
Output Low (SF set) $I_{\text{SF}} = 300 \mu\text{A}$	VSF			1	V

TIMING

PWM frequency - $C_{\text{CP}} = 33\text{nF}$	f			10	KHz
Maximum Switching Frequency During Current Limitation - $V_{\text{bat}} = 6 \dots 28\text{V} \dots C_{\text{CP}} = 33\text{nF}$	f			20	KHz
Output ON Delay $\text{IN1} \dots \rightarrow \text{OUT1}$ or $\text{IN2} \dots \rightarrow \text{OUT2}$	t_{don}			15	μs
Output OFF Delay $\text{IN1} \dots \rightarrow \text{OUT1}$ or $\text{IN2} \dots \rightarrow \text{OUT2}$	t_{doff}			15	μs
Output Switching Time - $C_{\text{CP}} = 0$ to 33nF $\text{OUTiH} \dots \rightarrow \text{OUTiL}$, $\text{OUTiL} \dots \rightarrow \text{OUTiH}$, $I_{\text{OUT}} = 3\text{A}$	t_r , t_f	2		5	μs
Disable Delay Time $\text{DI} \dots \rightarrow \text{OUTi}$	t_{ddis}			8	μs
Turn off in Case of Over-current or Over-temperature			4		μs
Power On Delay Time ($C_{\text{cp}} = 33\text{nF}$)			1	5	ms

TRUH TABLE

Device State	Input Conditions				Status		Outputs	
	DI1 (3)	DI2 (3)	IN1	IN2	SF (5)	SF (6)	OU1	OU2
1-Forward	L	H	H	L	H	H	H	L
2-Reverse	L	H	L	H	H	H	L	H
3-Free Wheeling Low	L	H	L	L	H	H	L	L
4-Free Wheeling High	L	H	H	H	H	H	H	H
5-Disable 1	H	X	X	X	L	H	Z	Z
6-Disable 2	X	L	X	X	L	H	Z	Z
7-IN1 Disconnected	L	H	Z	X	H	H	H	X
8-IN2 Disconnected	L	H	X	Z	H	H	X	H
9-DI1 Disconnected	Z	X	X	X	L	H	Z	Z
10-DI2 Disconnected	X	Z	X	X	L	H	Z	Z
11-Current Limit.active	L	H	X	X	H	H	Z	Z
12-Undervoltage (1)	X	X	X	X	L	L	Z	Z
13-Over-temperature (2)	X	X	X	X	L	L	Z	Z
14-Over-current (2)	X	X	X	X	L	L	Z	Z

NOTE :

(1) In case of undervoltage, tristate and status-flag are reset automatically.

(2) Whenever over-current or over-temperature is detected, the fault is stored (i.e.status-flag remains low).

The tristate conditions and the status-flag are reset via DI1 (IN1) or DI2 (IN2).

Pinnames in brackets refer to coding pin (COD=Vcc).

(3) If COD = Vcc then DI1 and DI2 are not active.

(4) In case of over-current, the time when the current is greater than 7,8A is lower than 30µs, with a maximum frequency of 1kHz.

(5) COD=nc or GND

(6) COD = VCC

L = Low

H = High

X = High or Low

Z = High impedance (all output stage transistors are switched off).

PINS FUNCTION DESCRIPTION

Pin	Name	Description
9, 10, 11, 12 Metal slug	GND	Power Ground
1	GND	Analog ground
2	Output Status-flag (SF)	Open drain output, active low. Is set according to the truth table .
3,13 18, 19	Inputs IN1,IN2 DI1,DI2, COD	Voltage controlled inputs with hysteresis
8	COD	When not connected or connected to GND, a stored failure will be reset by change of the voltage-level on DI1 or DI2. When connected to Vcc, the disable pin DI1 and DI2 are inactive. A stored failure will be reset by change of the voltage-level on IN1 or IN2 .
6, 7, 14, 15	OUT1 , OUT2	H-Bridge outputs with integrated free-wheeling diodes.
4, 5, 16	Vbat	<p>The pins 4 and 5 are internally connected. These pins supply the left high side and the analogue/logic part of the device. The pin 16 supplies the right high side and the charge pump. The pins 4, 5 and 16 should be connected together on the printed circuit board with connections as short as possible.</p> <p><i>Supervision and protection functions</i></p> <p><i>a) Supply voltage supervision</i> The supply voltage is supervised . If it is below its specific threshold , the power stages are switched in tristate and the status flag is switched low. If the supply voltage is over the specific threshold again , the power stage switches independently into normal operation, according to the input pins and the status flag is reset .</p> <p><i>b) Thermal supervision</i> In case of over-temperature the power stages are switched in tristate independent of the inputs signals and the status flag is switched low. If the level changes from high to low on DI1 (IN1) or low to high on DI2 (IN2), the output stage switches on again if the temperature is below the specified limit .The status-flag is reset to high level (Pinnames in brackets refer to coding pin=Vcc).</p> <p><i>c) Supervision of overcurrent</i> If overcurrent is detected the power stages are independent of the inputs signals switched in tristate and the status flag is set . If the level changes from high to low on DI1 (IN1) or low to high on DI2 (IN2) the output stage switches on again and the status flag is reset to high level (Pinnames in brackets refer to coding pin = Vcc). The output stage switches into the mode defined by the inputs pins provided the temperature is below the specified limits .</p> <p><i>d) Current limiting</i> The maximum current which can flow under normal operating conditions is limited to $I_{max} = 6,5A \pm 20\%$.When the maximum current value is reached, the output stages are switched tristate for a fixed time. According to the time constant the current decreases until the next switch on occurs. See page 8 for schematics.</p>

Figure 1. Typical Application

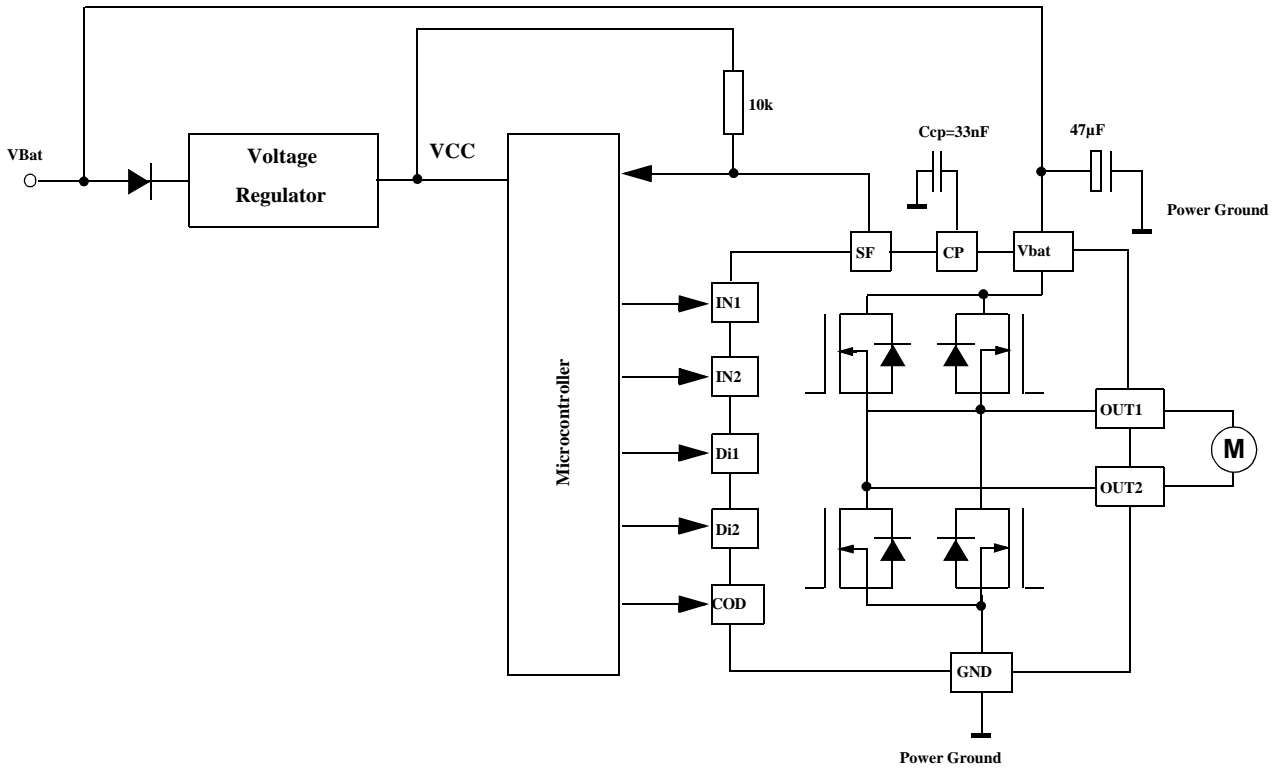

Figure 2. Output delay time

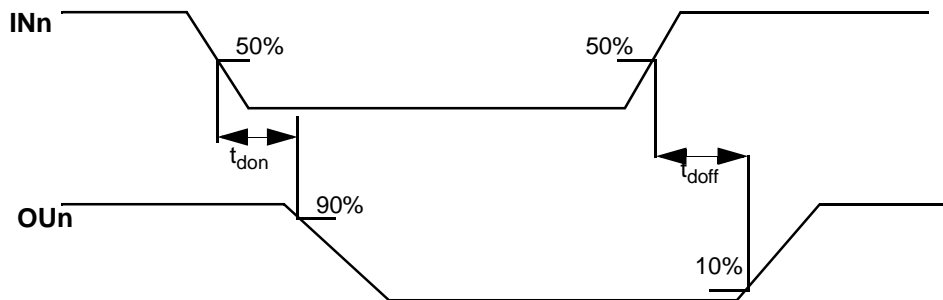

Figure 3. Disable Delay Time

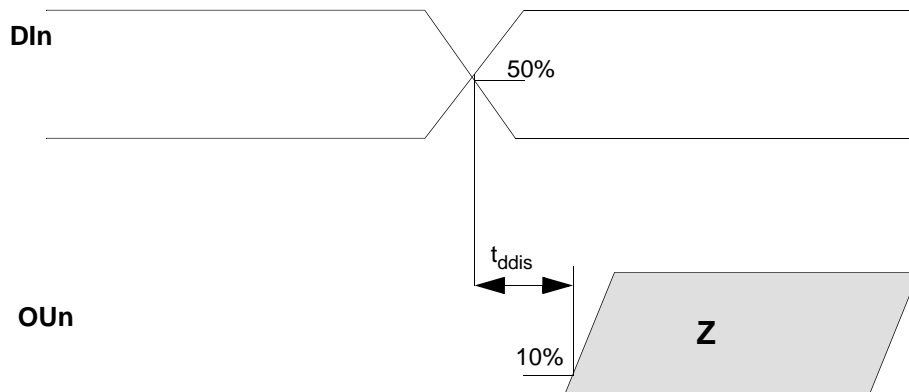

Figure 4. Output Switching Time

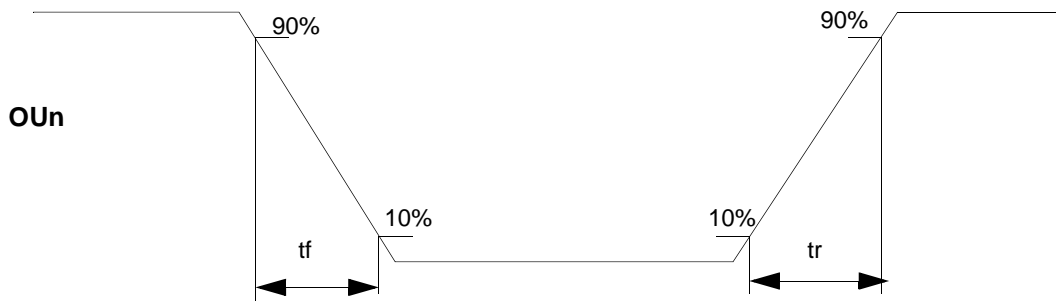

Figure 5. Current Limitation

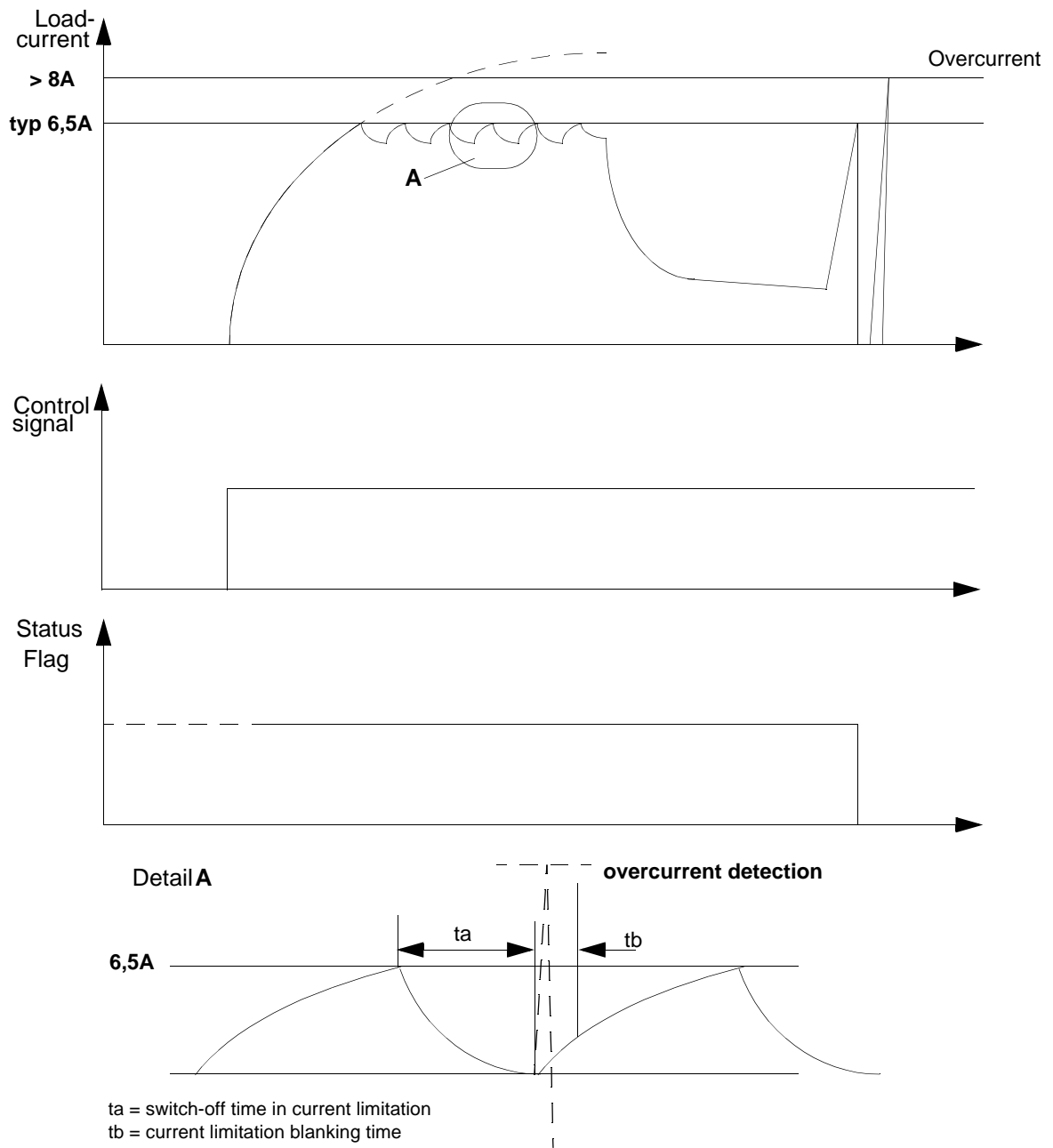

Figure 6 - Standby Current versus Temperature

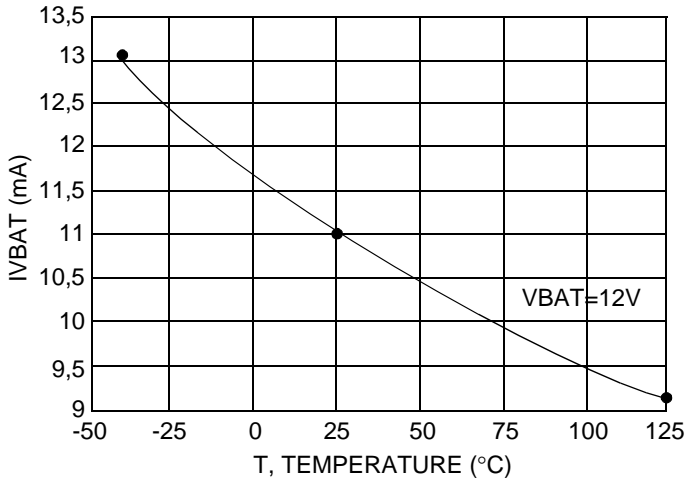

Figure 7. VBAT Undervoltage versus Temperature

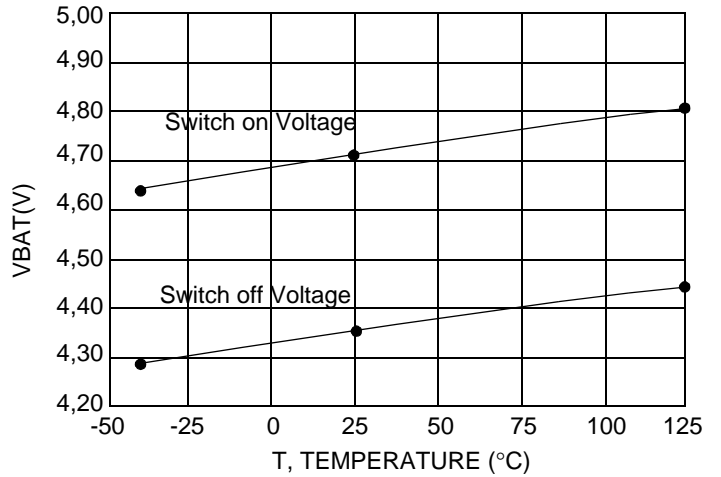

Figure 8 - Low Threshold Input Voltage versus Temperature

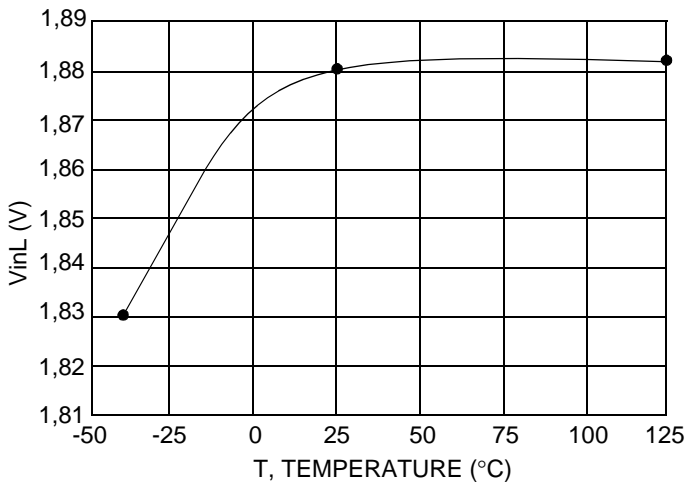

Figure 9 - High Threshold Input Voltage versus Temperature

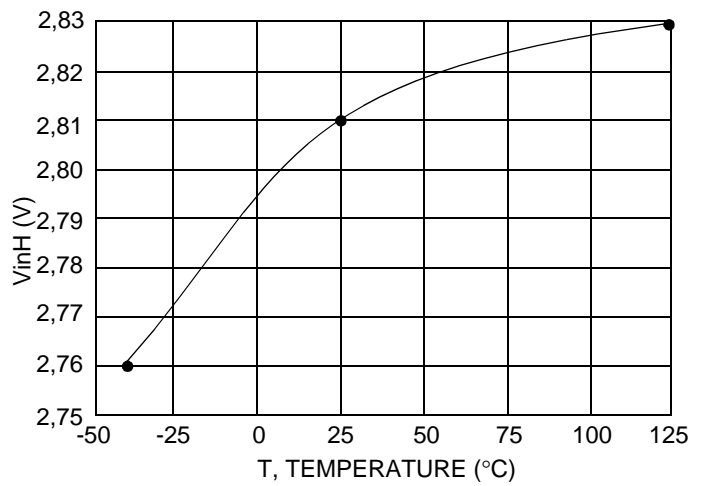

Figure 10 - Vcp versus Battery Voltage

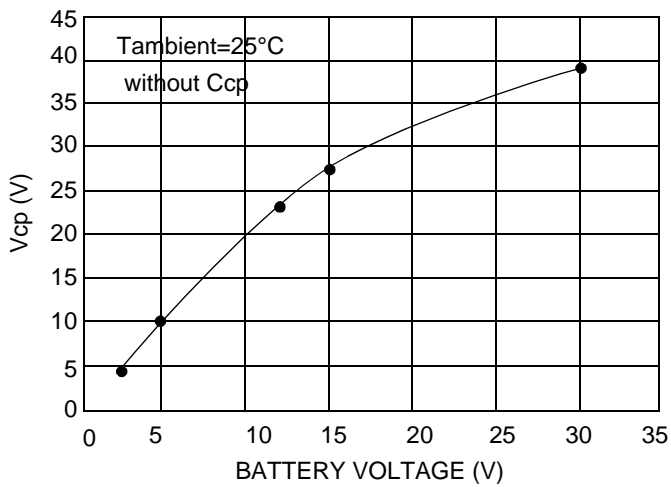

Figure 11. RDSON versus Temperature

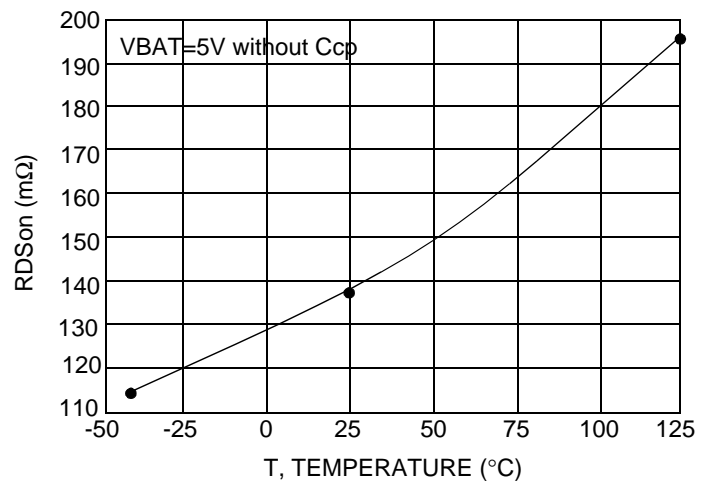

Figure 12. Switch off current versus Temperature

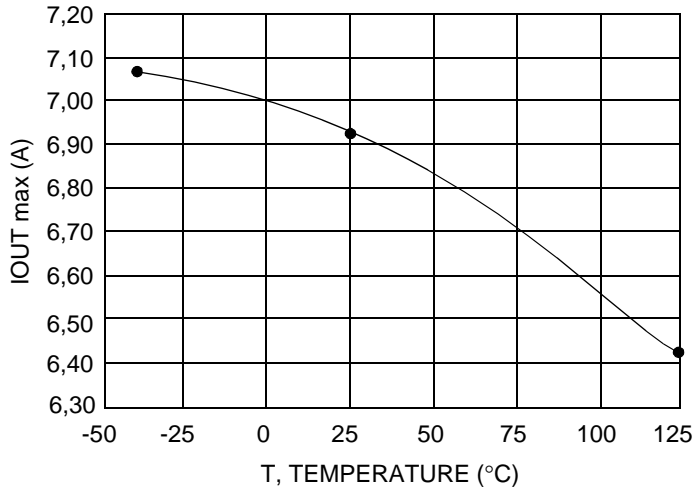

Figure 13. Over Current Detection versus Temperature

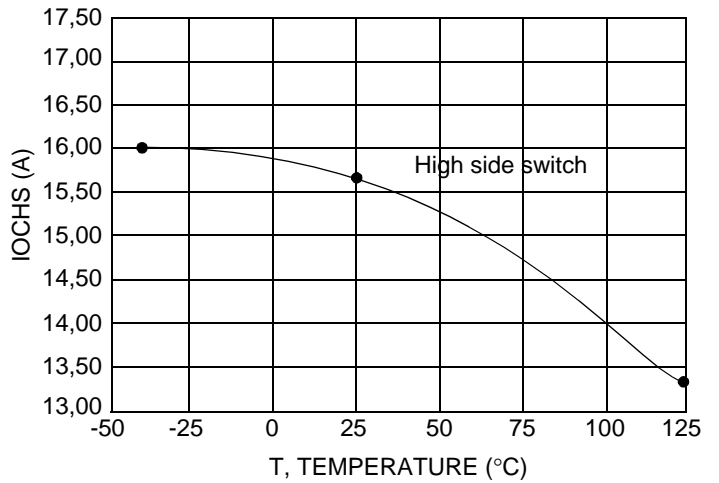

Figure 14. Current Limitation

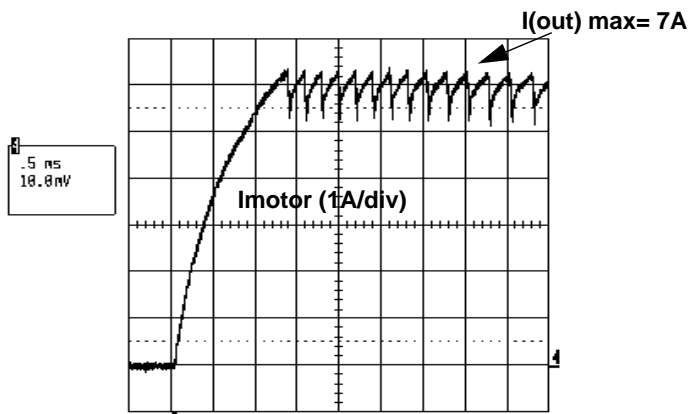

Figure 15. Switch off Time

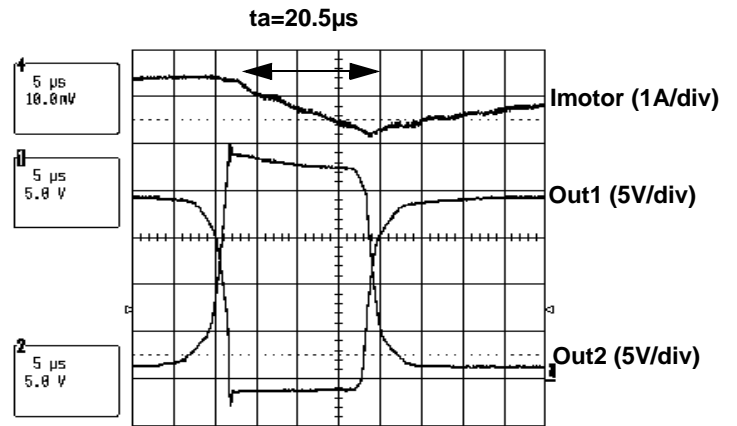

Figure 16. Output Switching Time: Tr

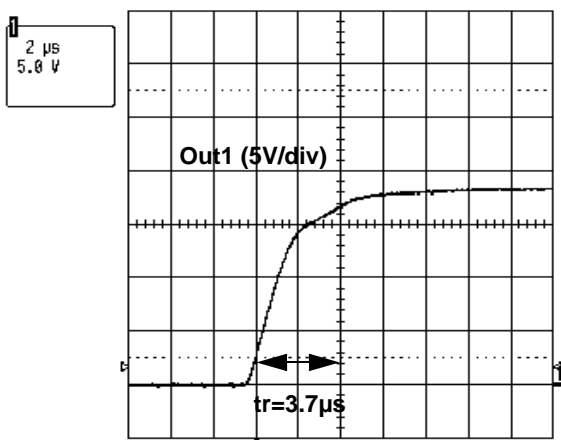

Figure 17. Output Switching Time: Tf

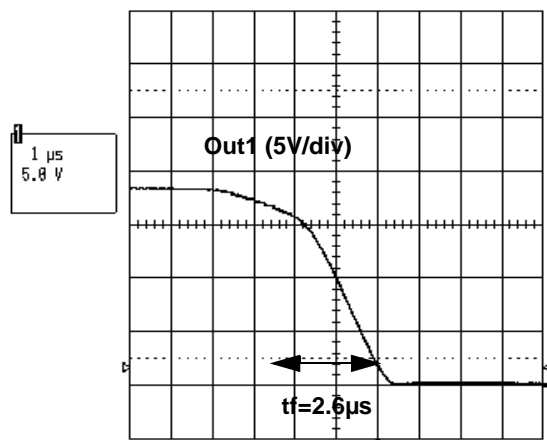

Figure 18. Output OFF Delay

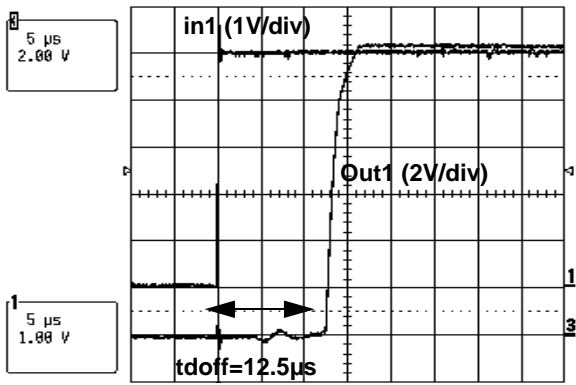

Figure 19. Output ON Delay

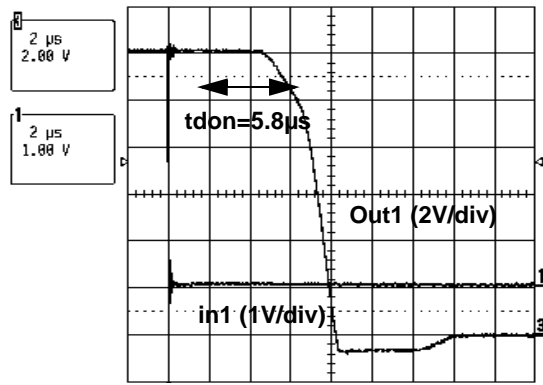

Figure 20. Disable Delay Time

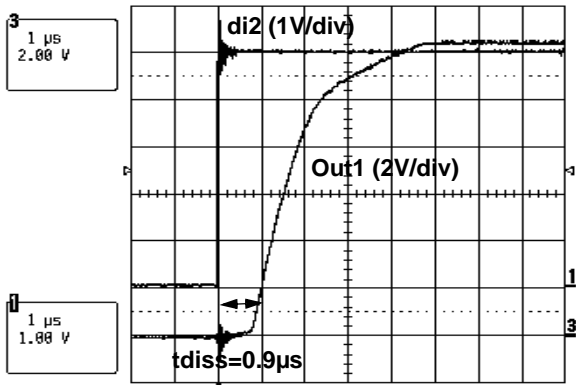
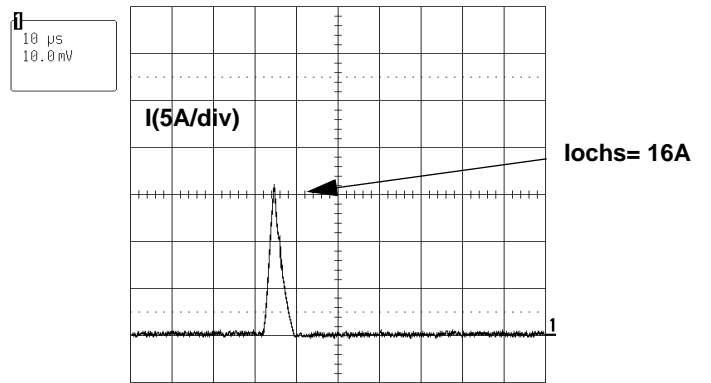

Figure 21. High side Overcurrent Detection



PACKAGE INFORMATION

The HSOP20 package is designed for enhanced thermal performance. The particularity of this package is its copper baseplate on which the power die is soldered. The baseplate is soldered on a PCB to provide heat flow to the ambient and also to provide a large thermal capacitance.

Of course, the more copper area on the PCB, the better the power dissipation and transient behaviour.

We characterized the HSOP20 on a double side PCB. The bottom side area of the copper is 7.8 cm^2 . The top surface is 2.7 cm^2 , see Figure 22.

Figure 22. PCB Test Layout

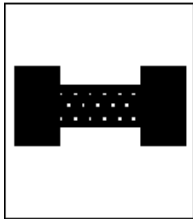

Top Side

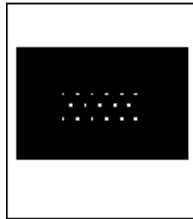

Bottom Side

Figure 23. PHSOP20 Thermal Response

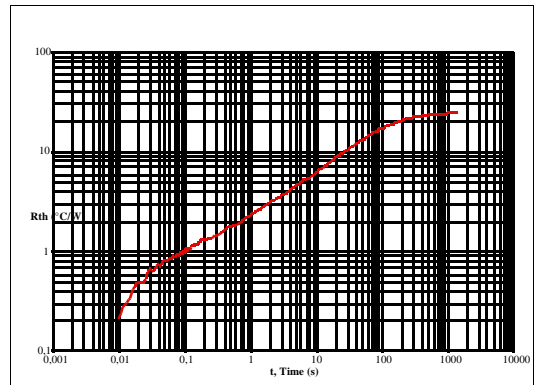
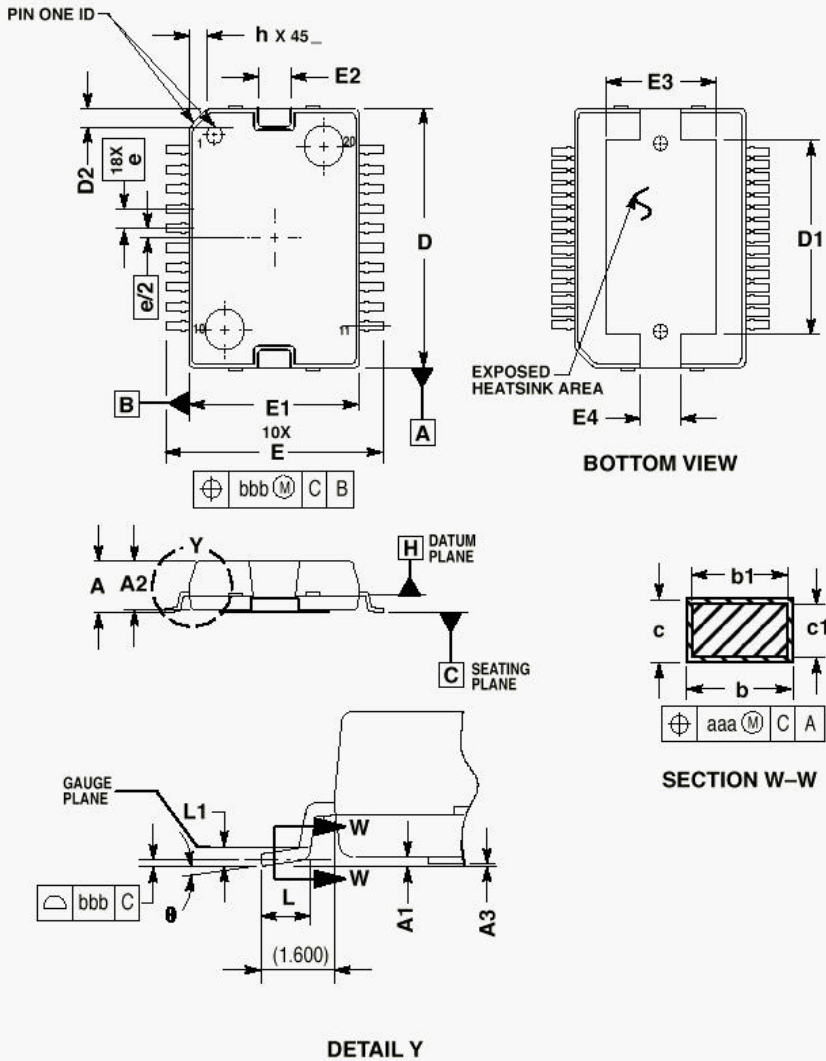

Figure 23 shows the thermal response with the device soldered on to the test PCB described on figure 22.

CASE OUTLINES



NOTES:

1. CONTROLLING DIMENSION: MILLIMETER.
2. DIMENSIONS AND TOLERANCES PER ASME Y14.5M, 1994.
3. DATUM PLANE -H- IS LOCATED AT BOTTOM OF LEAD AND IS COINCIDENT WITH THE LEAD WHERE THE LEAD EXITS THE PLASTIC BODY AT THE BOTTOM OF THE PARTING LINE.
4. DIMENSIONS D AND E1 DO NOT INCLUDE MOLD PROTRUSION. ALLOWABLE PROTRUSION IS 0.150 PER SIDE. DIMENSIONS D AND E1 DO INCLUDE MOLD MISMATCH AND ARE DETERMINED AT DATUM PLANE -H-.
5. DIMENSION b DOES NOT INCLUDE DAMBAR PROTRUSION. ALLOWABLE DAMBAR PROTRUSION SHALL BE 0.127 TOTAL IN EXCESS OF THE b DIMENSION AT MAXIMUM MATERIAL CONDITION.
6. DATUMS -A- AND -B- TO BE DETERMINED AT DATUM PLANE -H-.
7. DIMENSION D DOES NOT INCLUDE TIEBAR PROTRUSIONS. ALLOWABLE TIEBAR PROTRUSIONS ARE 0.150 PER SIDE.

DIM	MILLIMETERS	
	MIN	MAX
A	3.000	3.400
A1	0.100	0.300
A2	2.900	3.100
A3	0.00	0.100
D	15.800	16.000
D1	11.700	12.600
D2	0.900	1.100
E	13.950	14.450
E1	10.900	11.100
E2	2.500	2.700
E3	6.400	7.200
E4	2.700	2.900
L	0.840	1.100
L1	0.350 BSC	
b	0.400	0.520
b1	0.400	0.482
c	0.230	0.320
c1	0.230	0.280
e	1.270 BSC	
h	— 1.100	
ϕ	0	8
aaa	0.200	
bbb	0.100	

Motorola reserves the right to make changes without further notice to any products herein to improve reliability, function or design. Motorola does not assume any liability arising out of the application or use of any product or circuit described herein ; neither does it convert any licence under its patent rights of others. Motorola products are not authorized for use as components in life support devices or systems intended for surgical implant into the body or intended to support or sustain life. Buyer agrees to notify Motorola of any such intended end use whereupon Motorola shall determine availability and suitability of its products for the use intended. Motorola and are registered trademarks of Motorola, Inc. Motorola, Inc. is an Equal Employment opportunity/Affirmative Action Employer.