

## MM5486 LED Display Driver

### General Description

The MM5486 is a monolithic MOS integrated circuit utilizing N-channel metal-gate low-threshold, enhancement mode and ion-implanted depletion mode devices. It is available in a 40-pin molded dual-in-line package. The MM5486 is designed to drive common anode-separate cathode LED displays. A single pin controls the LED display brightness by setting a reference current through a variable resistor connected to V<sub>DD</sub>.

### Features

- Continuous brightness control
- Serial data input/output

- External load input
- Cascaded operation capability
- Wide power supply operation
- TTL compatibility
- 33 outputs, 15 mA sink capability
- Alphanumeric capability

### Applications

- COPSTM or microprocessor displays
- Industrial control indicator
- Relay driver
- Digital clock, thermometer, counter, voltmeter
- Instrumentation readouts

### Block and Connection Diagrams

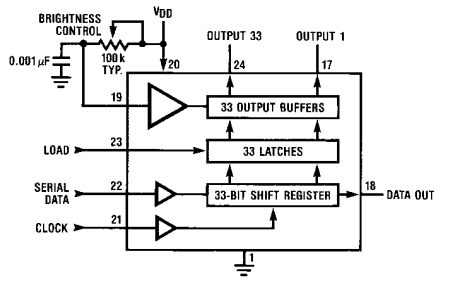
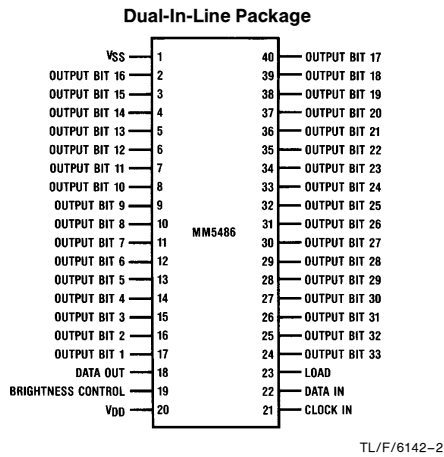

FIGURE 1



Top View

Order Number MM5486N  
See NS Package Number N40A

FIGURE 2

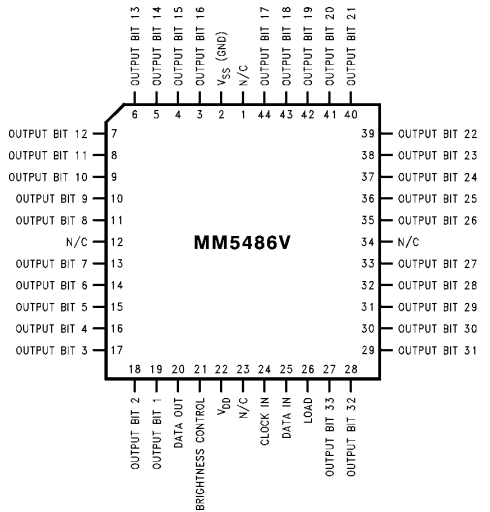

Order Number MM5486V  
See NS Package Number V44A

COPSTM is a trademark of National Semiconductor Corporation.

## Absolute Maximum Ratings

If Military/Aerospace specified devices are required, please contact the National Semiconductor Sales Office/Distributors for availability and specifications.

Voltage at Any Pin	$V_{SS}$ to $V_{SS} + 12V$
Operating Temperature	-25°C to +85°C
Storage Temperature	-65°C to +150°C

Power Dissipation at 25°C	
Molded DIP Package, Board Mount	2.5W*
Molded DIP Package, Socket Mount	2.3W**
Junction Temperature	+150°C
Lead Temperature (Soldering, 10 seconds)	300°C
*Molded DIP Package, Board Mount, $\theta_{JA} = 49^\circ\text{C/W}$ , Derate 20.4 mW/°C above 25°C.	
**Molded DIP Package, Socket Mount, $\theta_{JA} = 54^\circ\text{C/W}$ , Derate 18.5 mW/°C above 25°C.	

## Electrical Characteristics

$T_A$  within operating range,  $V_{DD} = 4.75V$  to  $11.0V$ ,  $V_{SS} = 0V$ , unless otherwise specified

Symbol	Parameter	Conditions	Min	Typ	Max	Units
$V_{DD}$	Power Supply		4.75		11	V
$I_{DD}$	Power Supply Current	Excluding Output Loads			7	mA
$V_{IL}$ $V_{IH}$	Input Voltages Logic "0" Level Logic "1" Level	$\pm 10 \mu A$ Input Bias $4.75 \leq V_{DD} \leq 5.25$	-0.3 2.2		0.8 $V_{DD}$	V V
		$V_{DD} > 5.25$	$V_{DD} - 2$		$V_{DD}$	V
$I_{BR}$	Brightness Input (Note 2)		0		0.75	mA
$I_{OH}$ $I_{OL}$	Output Sink Current (Note 3) Segment OFF Segment ON	$V_{OUT} = 3.0V$ $V_{OUT} = 1V$ (Note 4) Brightness Input = $0 \mu A$ Brightness Input = $100 \mu A$ Brightness Input = $750 \mu A$	0 2.0 15	2.7	10 10 4 25	$\mu A$ $\mu A$ mA mA
$I_O$	Maximum Segment Current				40	mA
$V_{IBR}$	Brightness Input Voltage (Pin 19)	Input Current = $750 \mu A$	3.0		4.3	V
OM	Output Matching (Note 1)				$\pm 20$	%
$V_{OL}$ $V_{OH}$	Data Output Logical "0" Level Logical "1" Level	$I_{OUT} = 0.5 mA$ $I_{OUT} = 100 \mu A$	$V_{SS}$ 2.4		0.4 $V_{DD}$	V V
$f_C$ $t_h$ $t_l$	Clock Input Frequency High Time Low Time	(Notes 5 and 6)			500	kHz ns ns
$t_{DS}$ $t_{DH}$	Data Input Set-Up Time Hold Time		300 300			ns ns

**Note 1:** Output matching is calculated as the percent variation  $(I_{MAX} + I_{MIN})/2$ .

**Note 2:** With a fixed resistor on the brightness input pin, some variation in brightness will occur from one device to another. Maximum brightness input current can be 2 mA as long as Note 3 and junction temperature equation are complied with.

**Note 3:** Absolute maximum for each output should be limited to 40 mA.

**Note 4:** The  $V_{OUT}$  voltage should be regulated by the user. See Figures 6 and 7 for allowable  $V_{OUT}$  vs  $I_{OUT}$  operation.

**Note 5:** AC input waveform specification for test purpose:  $t_r \leq 20 ns$ ,  $t_f \leq 20 ns$ ,  $f = 500 kHz$ , 50%  $\pm 10\%$  duty cycle.

**Note 6:** Clock input rise and fall times must not exceed 300 ns.

## Functional Description

The MM5486 is specifically designed to operate four-digit alphanumeric displays with minimal interface with the display and the data source. Serial data transfer from the data source to the display driver is accomplished with 3 signals, serial data, clock, and load. The data bits are latched by a positive-level load signal, thus providing non-multiplexed, direct drive to the display. When load is high, the data in the shift registers is displayed on the output drivers. Outputs change only if the serial data bits differ from the previous time. Display brightness is determined by control of the output current for LED displays. A 0.001  $\mu\text{F}$  capacitor should be connected to brightness control, pin 19, to prevent possible oscillations. The output current is typically 20 times greater than the current into pin 19, which is set by an external variable resistor. There is an internal limiting resistor of 400 $\Omega$  nominal value.

A block diagram is shown in *Figure 1*.

*Figure 4* shows the input data format. Bit "1" is the first bit into the data input pin and it will appear on pin 17. A logical "1" at the input will turn on the appropriate LED. The load signal latches the 33 bits of the shift register into the latches. The data out pin allows for cascading the shift registers for more than 33 output drivers.

When the chip first powers ON, an internal power ON reset signal is generated which resets all registers and latches. The leading clock returns the chip to its normal operation.

*Figure 3* shows the timing relationship between data, clock and data enable. A maximum clock frequency of 0.5 MHz is assumed.

For applications where a lesser number of outputs are used, it is possible to either increase the current per output, or operate the part at higher than 1V  $V_{\text{OUT}}$ . The following equation can be used for calculations:

$$T_J = (V_{\text{OUT}}) (I_{\text{LED}}) (\text{No. of segments}) (\theta_{\text{JA}}) + T_A$$

where:

$T_J$  = junction temperature, 150°C max.

$V_{\text{OUT}}$  = the voltage at the LED driver outputs

$I_{\text{LED}}$  = the LED current

$\theta_{\text{JA}}$  = thermal coefficient of the package

$T_A$  = ambient temperature

$\theta_{\text{JA}}$  (Socket Mount) = 54°C/W

$\theta_{\text{JA}}$  (Board Mount) = 49°C/W

The above equation was used to plot *Figure 6*, *Figure 7*, and *Figure 8*.

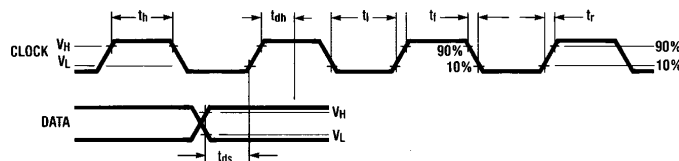
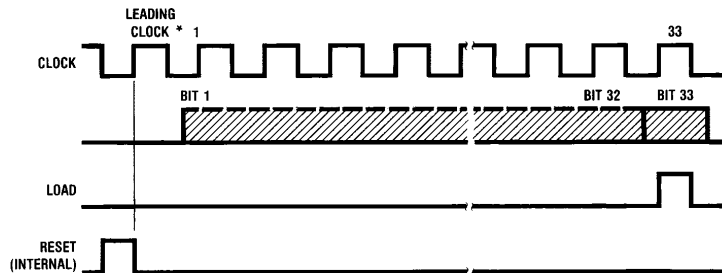

FIGURE 3

TL/F/6142-3



\*This leading clock is necessary only after power ON.

FIGURE 4. Input Data Format

TL/F/6142-4

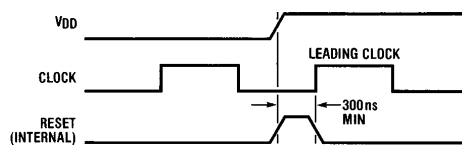

FIGURE 5

TL/F/6142-5

# Typical Applications

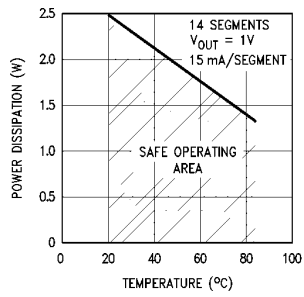

FIGURE 6  
TL/F/6142-6

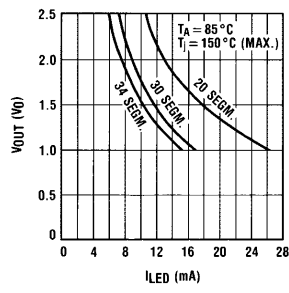

FIGURE 7  
TL/F/6142-7

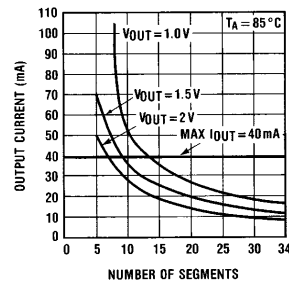
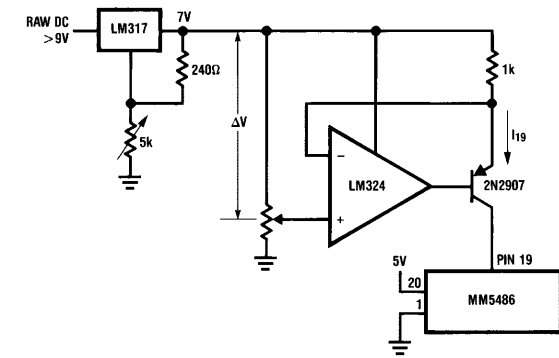

FIGURE 8  
TL/F/6142-8



$$I_{19} = \frac{\Delta V}{1k}$$

FIGURE 9. Constant Current Brightness Control

TL/F/6142-9

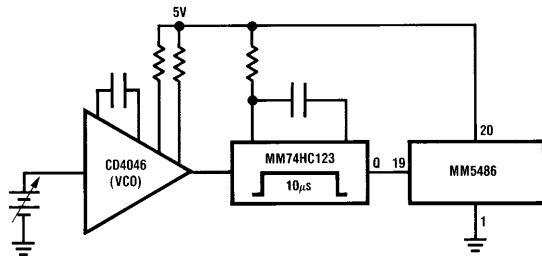
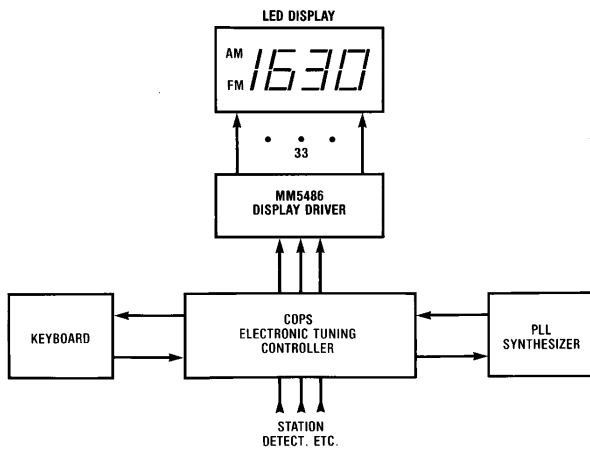

FIGURE 10. Brightness Control Varying the Duty Cycle

TL/F/6142-10

**Typical Applications** (Continued)

**Basic Electronically Tuned Radio System**



TL/F/6142-11

**Duplexing 8 Digits with One MM5486**

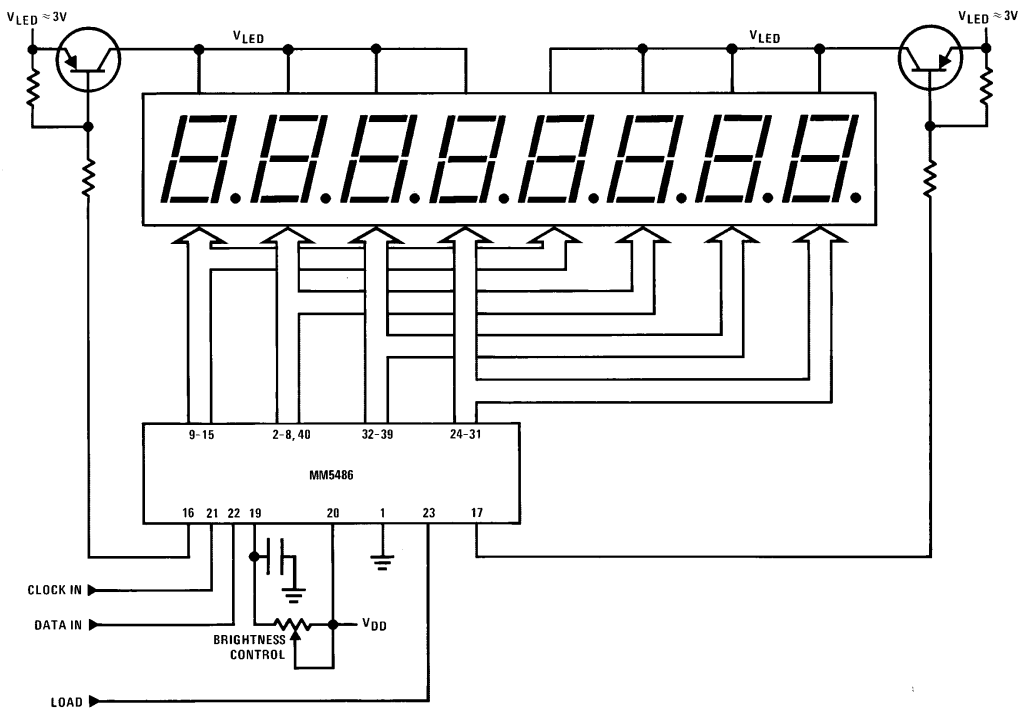

TL/F/6142-12

\*This driver has 7 segments only.



**Physical Dimensions** inches (millimeters)

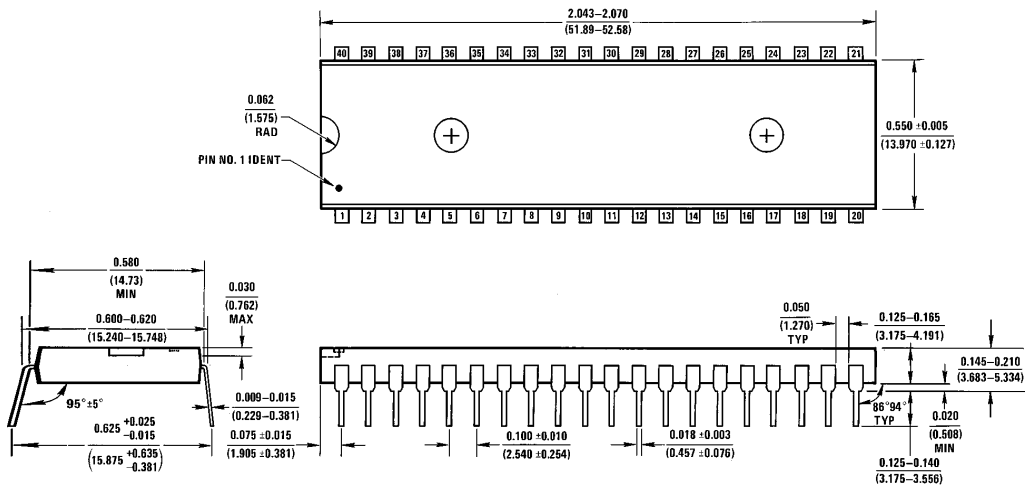

**Molded Dual-In-Line Package (N)**  
**Order Number MM5486**  
**NS Package Number N40A**

NA0A (REV 6)

**Physical Dimensions** inches (millimeters) (Continued)

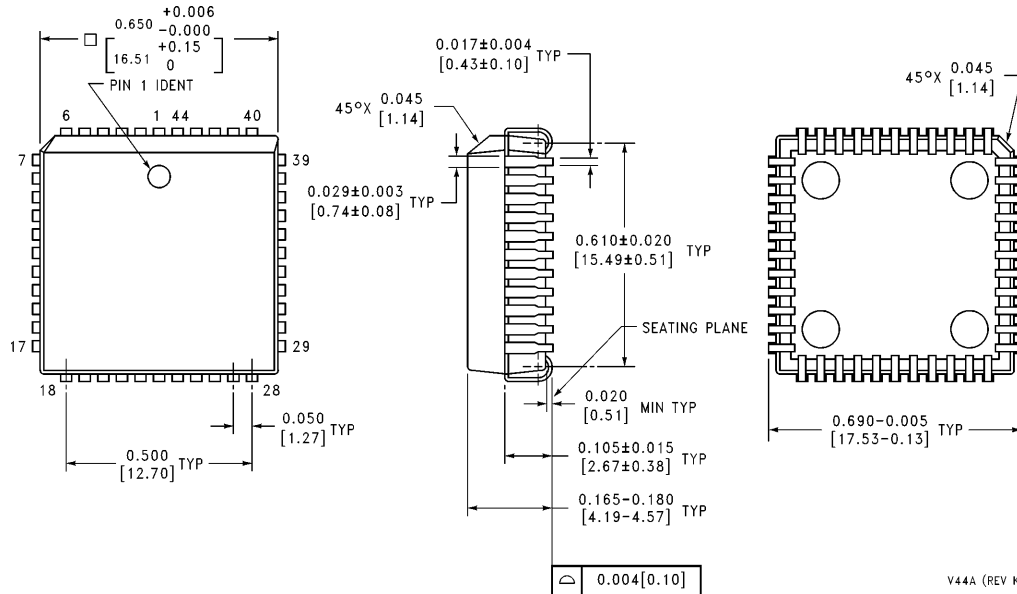

V44A (REV K)

**44-Lead Plastic Chip Carrier (V)  
Order Number MM5486V  
NS Package Number V44A**

**LIFE SUPPORT POLICY**

NATIONAL'S PRODUCTS ARE NOT AUTHORIZED FOR USE AS CRITICAL COMPONENTS IN LIFE SUPPORT DEVICES OR SYSTEMS WITHOUT THE EXPRESS WRITTEN APPROVAL OF THE PRESIDENT OF NATIONAL SEMICONDUCTOR CORPORATION. As used herein:

1. Life support devices or systems are devices or systems which, (a) are intended for surgical implant into the body, or (b) support or sustain life, and whose failure to perform, when properly used in accordance with instructions for use provided in the labeling, can be reasonably expected to result in a significant injury to the user.
2. A critical component is any component of a life support device or system whose failure to perform can be reasonably expected to cause the failure of the life support device or system, or to affect its safety or effectiveness.



**National Semiconductor Corporation**  
1111 West Bardin Road  
Arlington, TX 76017  
Tel: 1(800) 272-9959  
Fax: 1(800) 737-7018

**National Semiconductor Europe**  
Fax: (+49) 0-180-530 85 86  
Email: cnjwge@tevm2.nsc.com  
Deutsch Tel: (+49) 0-180-530 85 85  
English Tel: (+49) 0-180-532 78 32  
Français Tel: (+49) 0-180-532 93 58  
Italiano Tel: (+49) 0-180-534 16 80

**National Semiconductor Hong Kong Ltd.**  
19th Floor, Straight Block,  
Ocean Centre, 5 Canton Rd.  
Tsimshatsui, Kowloon  
Hong Kong  
Tel: (852) 2737-1600  
Fax: (852) 2736-9960

**National Semiconductor Japan Ltd.**  
Tel: 81-043-299-2309  
Fax: 81-043-299-2408

National does not assume any responsibility for use of any circuitry described, no circuit patent licenses are implied and National reserves the right at any time without notice to change said circuitry and specifications.



This datasheet has been downloaded from:

[www.DatasheetCatalog.com](http://www.DatasheetCatalog.com)

Datasheets for electronic components.

# National Semiconductor was acquired by Texas Instruments.

[http://www.ti.com/corp/docs/investor\\_relations/pr\\_09\\_23\\_2011\\_national\\_semiconductor.html](http://www.ti.com/corp/docs/investor_relations/pr_09_23_2011_national_semiconductor.html)

This file is the datasheet for the following electronic components:

MM5486V - <http://www.ti.com/product/mm5486v?HQS=TI-null-null-dscatalog-df-pf-null-ww>

MM5486N - <http://www.ti.com/product/mm5486n?HQS=TI-null-null-dscatalog-df-pf-null-ww>