



# STB75NF75 STP75NF75 - STP75NF75FP

N-channel 75V - 0.0095Ω - 80A - TO-220 - TO-220FP - D<sup>2</sup>PAK  
STripFET™ II Power MOSFET

## General features

Type	V <sub>DSS</sub>	R <sub>DS(on)</sub>	I <sub>D</sub>
STB75NF75	75V	<0.011Ω	80A <sup>(1)</sup>
STP75NF75	75V	<0.011Ω	80A <sup>(1)</sup>
STP75NF75FP	75V	<0.011Ω	80A <sup>(1)</sup>

1. Current limited by package

- Exceptional dv/dt capability
- 100% avalanche tested

## Description

This Power MOSFET series realized with STMicroelectronics unique STripFET™ process has specifically been designed to minimize input capacitance and gate charge. It is therefore suitable as primary switch in advanced high-efficiency, high-frequency isolated DC-DC converters for Telecom and Computer applications. It is also intended for any applications with low gate drive requirements.

## Applications

- Switching application

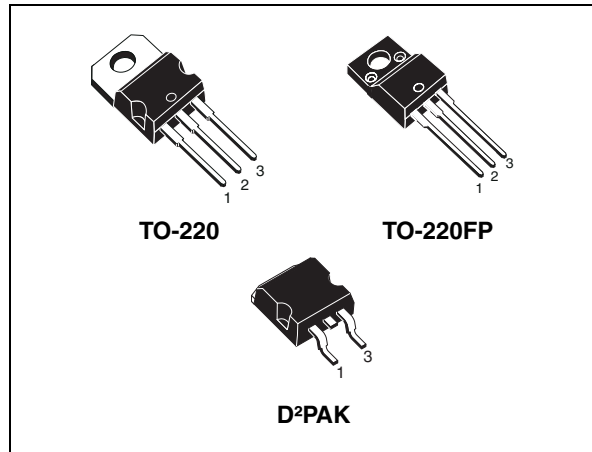

## Internal schematic diagram

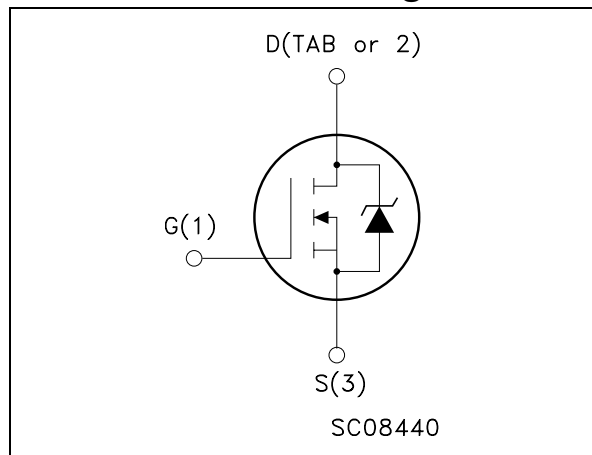

## Order codes

Part number	Marking	Package	Packaging
STB75NF75T4	B75NF75	D <sup>2</sup> PAK	Tape & reel
STP75NF75	P75NF75	TO-220	Tube
STP75NF75FP	P75NF75	TO-220FP	Tube

# Contents

<b>1</b>	<b>Electrical ratings</b> .....	<b>3</b>
<b>2</b>	<b>Electrical characteristics</b> .....	<b>4</b>
	2.1 Electrical characteristics (curves) .....	6
<b>3</b>	<b>Test circuit</b> .....	<b>9</b>
<b>4</b>	<b>Package mechanical data</b> .....	<b>10</b>
<b>5</b>	<b>Packaging mechanical data</b> .....	<b>14</b>
<b>6</b>	<b>Revision history</b> .....	<b>15</b>

# 1 Electrical ratings

**Table 1. Absolute maximum ratings**

Symbol	Parameter	Value		Unit
		D <sup>2</sup> PAK /TO-220	TO-220FP	
V <sub>DS</sub>	Drain-source voltage (V <sub>GS</sub> = 0)	75		V
V <sub>DGR</sub>	Drain-gate voltage (R <sub>GS</sub> = 20KΩ)	75		V
V <sub>GS</sub>	Gate-source voltage	± 20		V
I <sub>D</sub> <sup>(1)</sup>	Drain current (continuous) at T <sub>C</sub> = 25°C	80	80	A
I <sub>D</sub> <sup>(1)</sup>	Drain current (continuous) at T <sub>C</sub> =100°C	70	70	A
I <sub>DM</sub> <sup>(2)</sup>	Drain current (pulsed)	320	320	A
P <sub>TOT</sub>	Total dissipation at T <sub>C</sub> = 25°C	300	45	W
	Derating factor	2.0	0.3	W/°C
dv/dt <sup>(3)</sup>	Peak diode recovery voltage slope	12		V/ns
E <sub>AS</sub> <sup>(4)</sup>	Single pulse avalanche energy	700		mJ
V <sub>ISO</sub>	Insulation withstand voltage (RMS) from all three leads to external heat sink (t=1s;T <sub>C</sub> =25°C)	--	2000	V
T <sub>J</sub> T <sub>stg</sub>	Operating junction temperature Storage temperature	-55 to 175		°C

1. Current limited by package
2. Pulse width limited by safe operating area
3. I<sub>SD</sub> ≤80A, di/dt ≤300A/μs, V<sub>DD</sub> ≤V<sub>(BR)DSS</sub>, T<sub>J</sub> ≤T<sub>JMAX</sub>
4. Starting T<sub>J</sub> = 25 °C, I<sub>D</sub> = 40A, V<sub>DD</sub> = 37.5V

**Table 2. Thermal data**

Symbol	Parameter	Value		Unit
		D <sup>2</sup> PAK /TO-220	TO-220FP	
R <sub>thJC</sub>	Thermal resistance junction-case max	0.5	3.33	°C/W
R <sub>thJA</sub>	Thermal resistance junction-ambient max	62.5		°C/W
T <sub>l</sub>	Maximum lead temperature for soldering purpose <sup>(1)</sup>	300		°C

1. 1.6mm from case for 10sec)

## 2 Electrical characteristics

( $T_{CASE}=25^{\circ}C$  unless otherwise specified)

**Table 3. On/off states**

Symbol	Parameter	Test conditions	Min.	Typ.	Max.	Unit
$V_{(BR)DSS}$	Drain-source breakdown voltage	$I_D = 250\mu A, V_{GS} = 0$	75			V
$I_{DSS}$	Zero gate voltage drain current ( $V_{GS} = 0$ )	$V_{DS} = \text{Max rating},$ $V_{DS} = \text{Max rating} @ 125^{\circ}C$			1 10	$\mu A$ $\mu A$
$I_{GSS}$	Gate body leakage current ( $V_{DS} = 0$ )	$V_{GS} = \pm 20V$			$\pm 100$	nA
$V_{GS(th)}$	Gate threshold voltage	$V_{DS} = V_{GS}, I_D = 250\mu A$	2	3	4	V
$R_{DS(on)}$	Static drain-source on resistance	$V_{GS} = 10V, I_D = 40A$		0.0095	0.011	$\Omega$

**Table 4. Dynamic**

Symbol	Parameter	Test conditions	Min.	Typ.	Max.	Unit
$g_{fs}^{(1)}$	Forward transconductance	$V_{DS} = 15V, I_D = 40A$		20		S
$C_{iss}$	Input capacitance	$V_{DS} = 25V, f = 1 \text{ MHz},$ $V_{GS} = 0$		3700		pF
$C_{oss}$	Output capacitance			730		pF
$C_{rss}$	Reverse transfer capacitance			240		pF
$Q_g$	Total gate charge	$V_{DD} = 60V, I_D = 80A$ $V_{GS} = 10V$		117	160	nC
$Q_{gs}$	Gate-source charge			27		nC
$Q_{gd}$	Gate-drain charge			47		nC

1. Pulsed: pulse duration=300 $\mu s$ , duty cycle 1.5%

**Table 5. Switching times**

Symbol	Parameter	Test conditions	Min.	Typ.	Max.	Unit
$t_{d(on)}$	Turn-on delay time	$V_{DD} = 37.5V, I_D = 45A,$ $R_G = 4.7\Omega, V_{GS} = 10V$ <i>Figure 15 on page 9</i>		25		ns
$t_r$	Rise time			100		ns
$t_{d(off)}$	Turn-off delay time			66		ns
$t_f$	Fall time			30		ns

**Table 6. Source drain diode**

Symbol	Parameter	Test conditions	Min	Typ.	Max	Unit
$I_{SD}$	Source-drain current				80	A
$I_{SDM}^{(1)}$	Source-drain current (pulsed)				320	A
$V_{SD}^{(2)}$	Forward on voltage	$I_{SD} = 80A, V_{GS} = 0$			1.5	V
$t_{rr}$	Reverse recovery time	$I_{SD} = 80A,$ $di/dt = 100A/\mu s,$ $V_{DD} = 25V, T_J = 150^\circ C$ <i>Figure 17 on page 9</i>		132		ns
$Q_{rr}$	Reverse recovery charge			660		nC
$I_{RRM}$	Reverse recovery current			10		A

1. Pulse width limited by safe operating area
2. Pulsed: pulse duration=300 $\mu s$ , duty cycle 1.5%

## 2.1 Electrical characteristics (curves)

Figure 1. Safe operating area for TO-220 - D<sup>2</sup>PAK

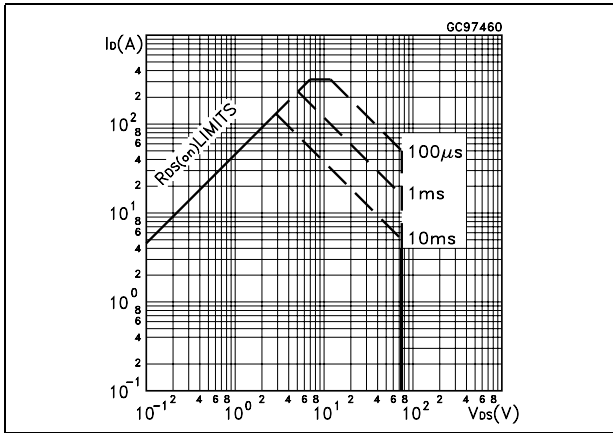

Figure 2. Thermal impedance for TO-220 - D<sup>2</sup>PAK

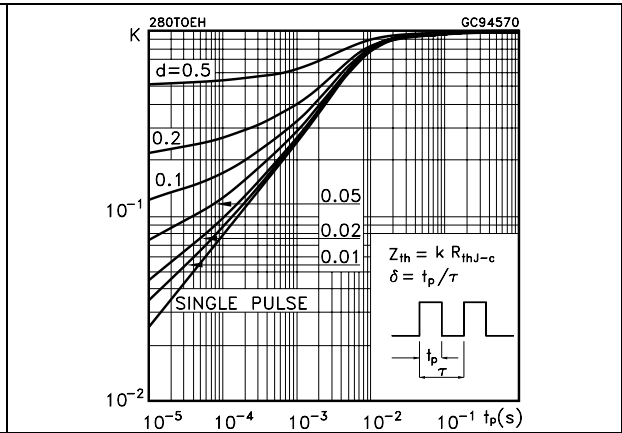

Figure 3. Safe operating area for TO-220FP

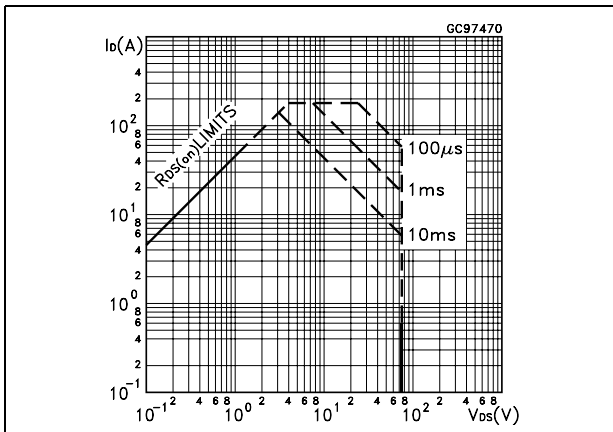

Figure 4. Thermal impedance for TO-220FP

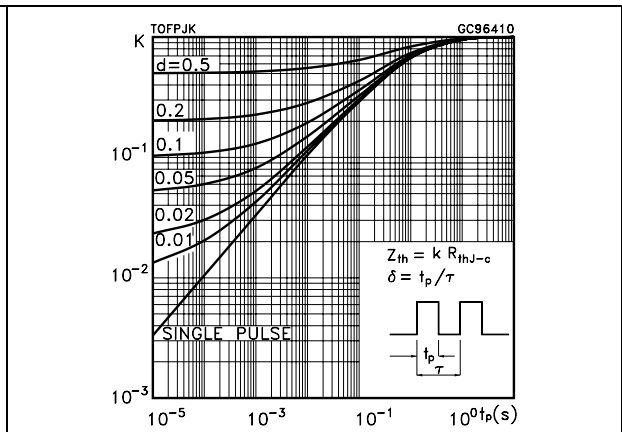

Figure 5. Output characteristics

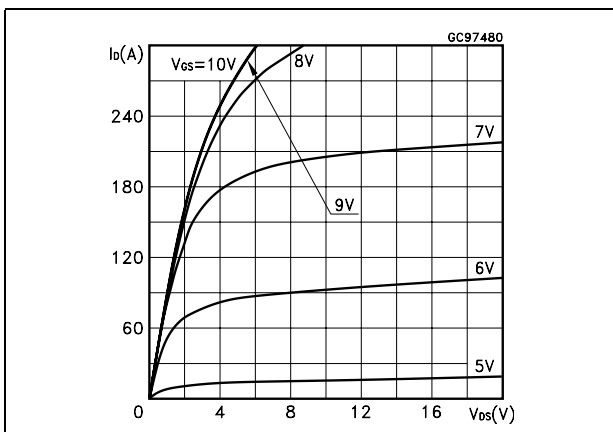

Figure 6. Transfer characteristics

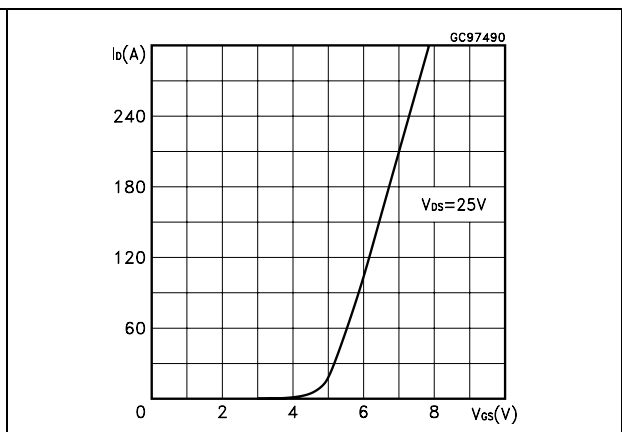

Figure 7. Transconductance

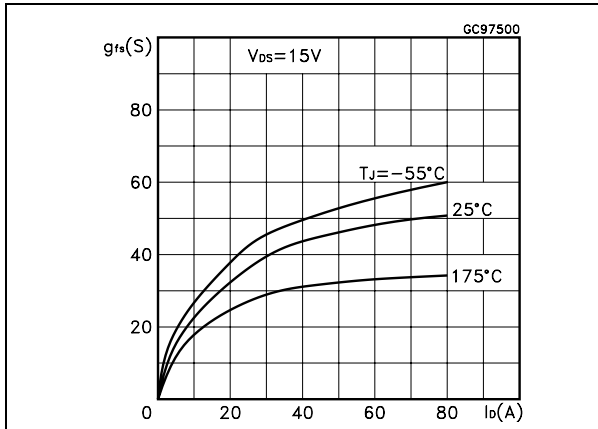

Figure 8. Static drain-source on resistance

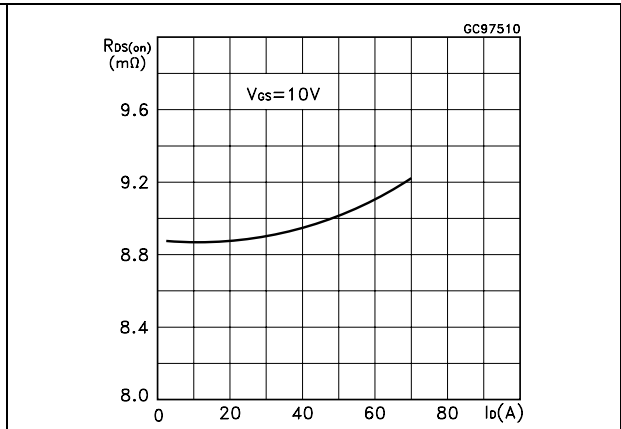

Figure 9. Gate charge vs gate-source voltage Figure 10. Capacitance variations

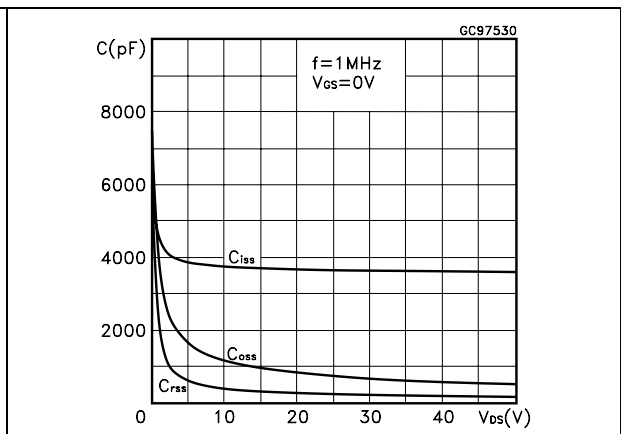
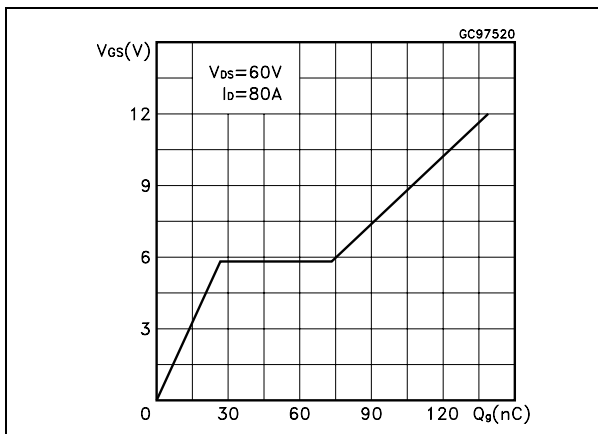

Figure 11. Normalized gate threshold voltage vs temperature

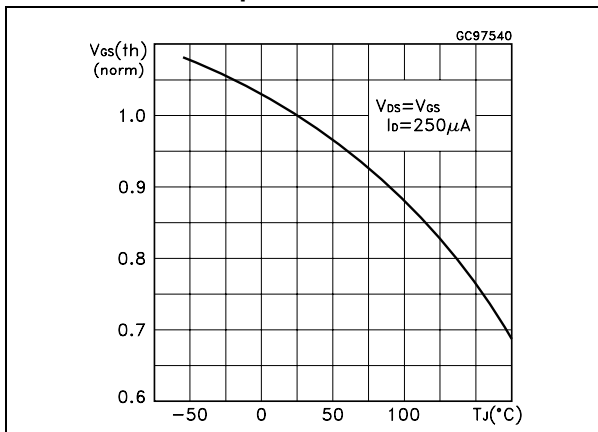

Figure 12. Normalized on resistance vs temperature

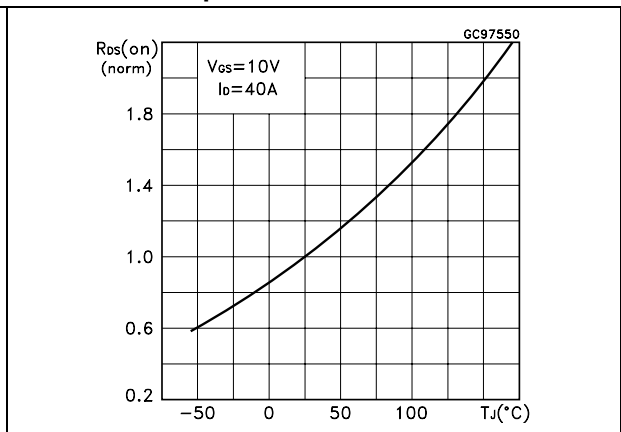

Figure 13. Source-drain diode forward characteristics

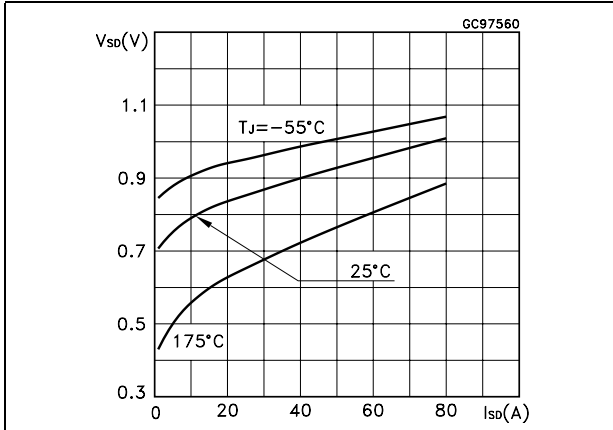
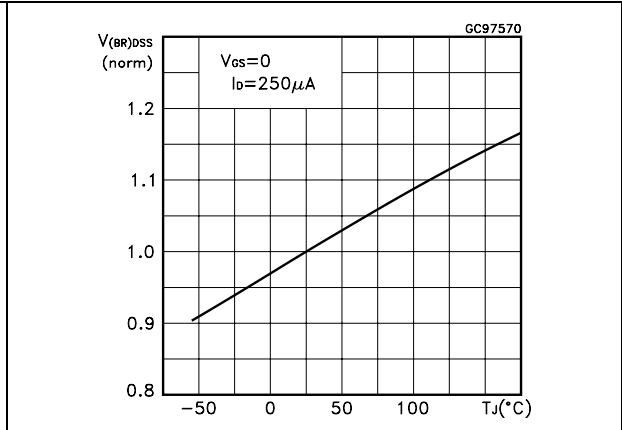

Figure 14. Normalized  $B_{VDSS}$  vs temperature





### 3 Test circuit

Figure 15. Switching times test circuit for resistive load



Figure 16. Gate charge test circuit



Figure 17. Test circuit for inductive load switching and diode recovery times



Figure 18. Unclamped inductive load test circuit



Figure 19. Unclamped inductive waveform

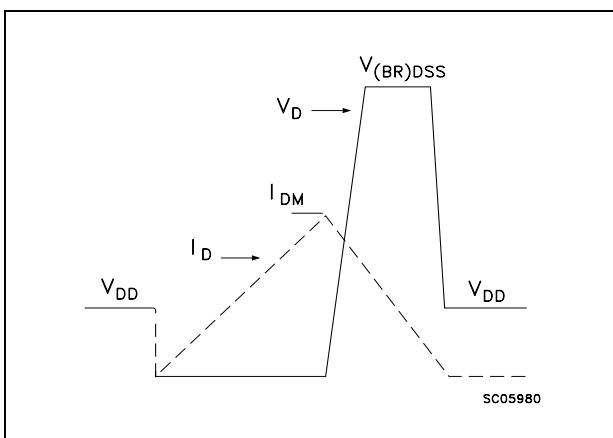

## 4 Package mechanical data

In order to meet environmental requirements, ST offers these devices in ECOPACK® packages. These packages have a Lead-free second level interconnect . The category of second level interconnect is marked on the package and on the inner box label, in compliance with JEDEC Standard JESD97. The maximum ratings related to soldering conditions are also marked on the inner box label. ECOPACK is an ST trademark. ECOPACK specifications are available at: [www.st.com](http://www.st.com)

## TO-220 MECHANICAL DATA

DIM.	mm.			inch		
	MIN.	TYP.	MAX.	MIN.	TYP.	MAX.
A	4.40		4.60	0.173		0.181
b	0.61		0.88	0.024		0.034
b1	1.15		1.70	0.045		0.066
c	0.49		0.70	0.019		0.027
D	15.25		15.75	0.60		0.620
E	10		10.40	0.393		0.409
e	2.40		2.70	0.094		0.106
e1	4.95		5.15	0.194		0.202
F	1.23		1.32	0.048		0.052
H1	6.20		6.60	0.244		0.256
J1	2.40		2.72	0.094		0.107
L	13		14	0.511		0.551
L1	3.50		3.93	0.137		0.154
L20		16.40			0.645	
L30		28.90			1.137	
øP	3.75		3.85	0.147		0.151
Q	2.65		2.95	0.104		0.116

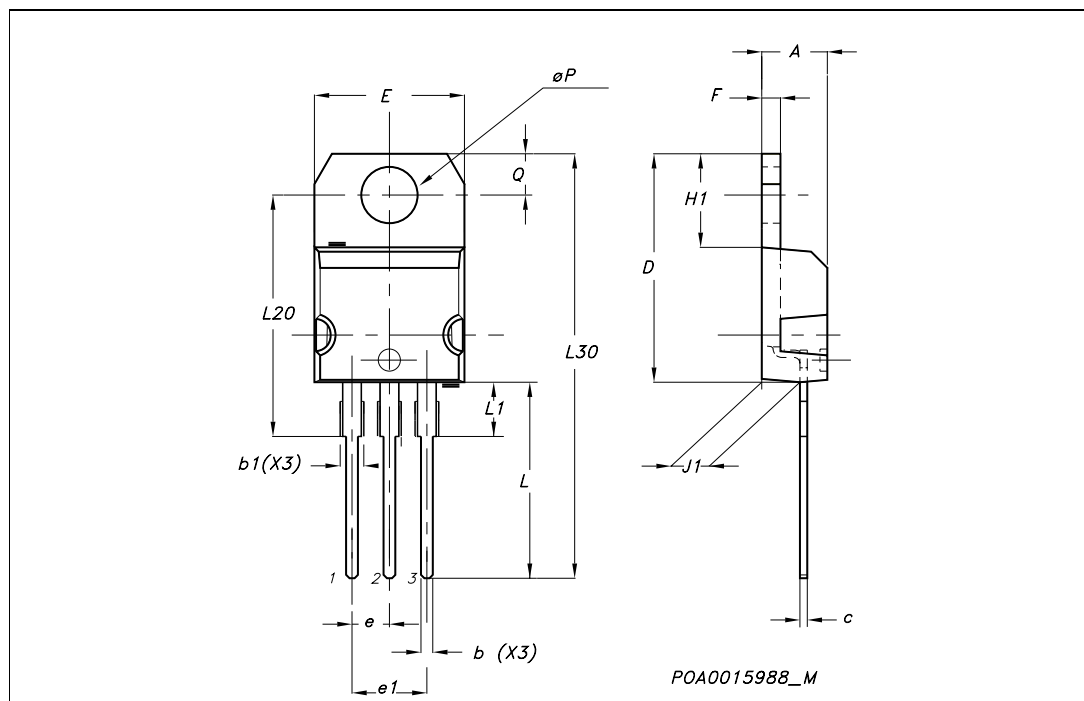

**D<sup>2</sup>PAK MECHANICAL DATA**

DIM.	mm.			inch		
	MIN.	TYP	MAX.	MIN.	TYP.	MAX.
A	4.4		4.6	0.173		0.181
A1	2.49		2.69	0.098		0.106
A2	0.03		0.23	0.001		0.009
B	0.7		0.93	0.027		0.036
B2	1.14		1.7	0.044		0.067
C	0.45		0.6	0.017		0.023
C2	1.23		1.36	0.048		0.053
D	8.95		9.35	0.352		0.368
D1		8			0.315	
E	10		10.4	0.393		
E1		8.5			0.334	
G	4.88		5.28	0.192		0.208
L	15		15.85	0.590		0.625
L2	1.27		1.4	0.050		0.055
L3	1.4		1.75	0.055		0.068
M	2.4		3.2	0.094		0.126
R		0.4			0.015	
V2	0°		4°			

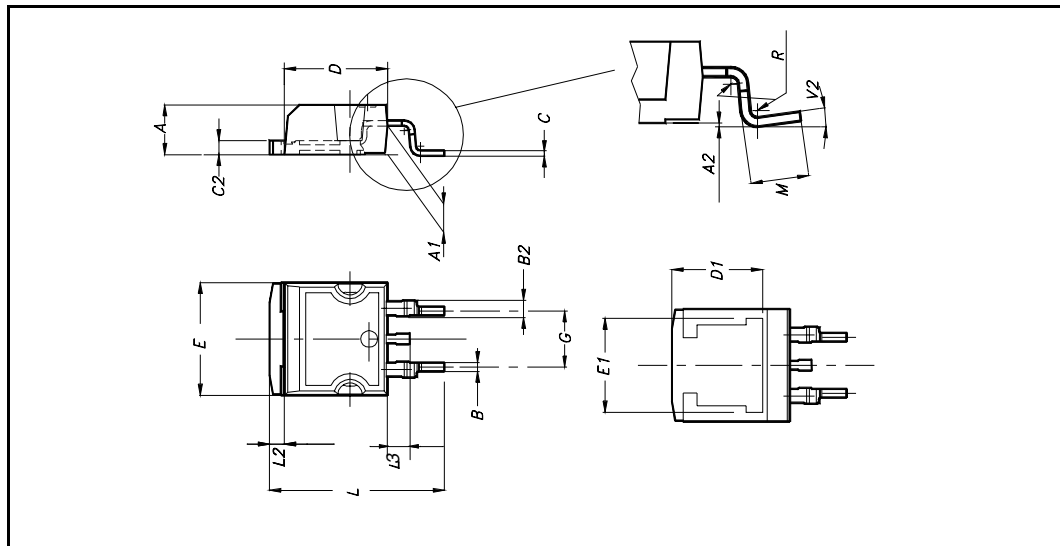

## TO-220FP MECHANICAL DATA

DIM.	mm.			inch		
	MIN.	TYP	MAX.	MIN.	TYP.	MAX.
A	4.4		4.6	0.173		0.181
B	2.5		2.7	0.098		0.106
D	2.5		2.75	0.098		0.108
E	0.45		0.7	0.017		0.027
F	0.75		1	0.030		0.039
F1	1.15		1.7	0.045		0.067
F2	1.15		1.7	0.045		0.067
G	4.95		5.2	0.195		0.204
G1	2.4		2.7	0.094		0.106
H	10		10.4	0.393		0.409
L2		16			0.630	
L3	28.6		30.6	1.126		1.204
L4	9.8		10.6	.0385		0.417
L5	2.9		3.6	0.114		0.141
L6	15.9		16.4	0.626		0.645
L7	9		9.3	0.354		0.366
Ø	3		3.2	0.118		0.126

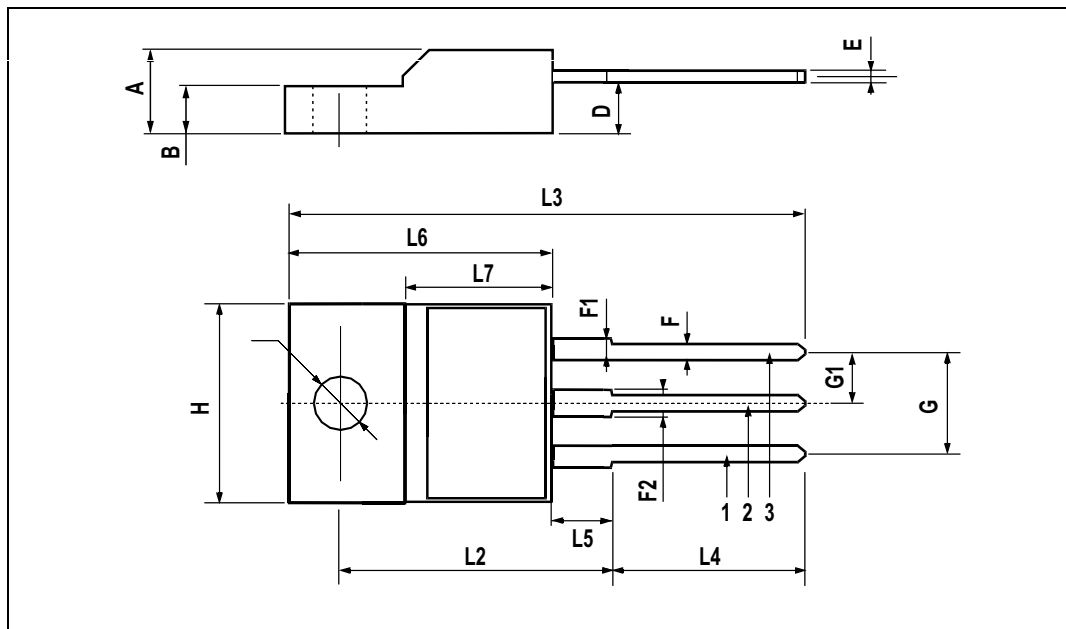

## 5 Packaging mechanical data

### D<sup>2</sup>PAK FOOTPRINT

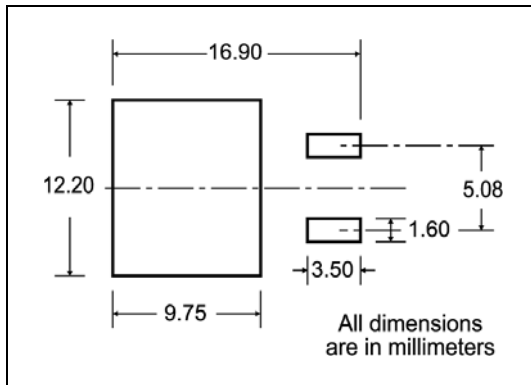

### TAPE AND REEL SHIPMENT

**TAPE MECHANICAL DATA**

DIM.	mm		inch	
	MIN.	MAX.	MIN.	MAX.
A0	10.5	10.7	0.413	0.421
B0	15.7	15.9	0.618	0.626
D	1.5	1.6	0.059	0.063
D1	1.59	1.61	0.062	0.063
E	1.65	1.85	0.065	0.073
F	11.4	11.6	0.449	0.456
K0	4.8	5.0	0.189	0.197
P0	3.9	4.1	0.153	0.161
P1	11.9	12.1	0.468	0.476
P2	1.9	2.1	0.075	0.082
R	50		1.574	
T	0.25	0.35	0.0098	0.0137
W	23.7	24.3	0.933	0.956

**REEL MECHANICAL DATA**

DIM.	mm		inch	
	MIN.	MAX.	MIN.	MAX.
A		330		12.992
B	1.5		0.059	
C	12.8	13.2	0.504	0.520
D	20.2		0.795	
G	24.4	26.4	0.960	1.039
N	100		3.937	
T		30.4		1.197

BASE QTY	BULK QTY
1000	1000

\* on sales type

## 6 Revision history

**Table 7. Revision history**

<b>Date</b>	<b>Revision</b>	<b>Changes</b>
03-Aug-2006	6	Complete version
15-Sep-2006	7	R <sub>DS(on)</sub> value update
27-Feb-2007	8	The document has been reformatted

**Please Read Carefully:**

Information in this document is provided solely in connection with ST products. STMicroelectronics NV and its subsidiaries ("ST") reserve the right to make changes, corrections, modifications or improvements, to this document, and the products and services described herein at any time, without notice.

All ST products are sold pursuant to ST's terms and conditions of sale.

Purchasers are solely responsible for the choice, selection and use of the ST products and services described herein, and ST assumes no liability whatsoever relating to the choice, selection or use of the ST products and services described herein.

No license, express or implied, by estoppel or otherwise, to any intellectual property rights is granted under this document. If any part of this document refers to any third party products or services it shall not be deemed a license grant by ST for the use of such third party products or services, or any intellectual property contained therein or considered as a warranty covering the use in any manner whatsoever of such third party products or services or any intellectual property contained therein.

**UNLESS OTHERWISE SET FORTH IN ST'S TERMS AND CONDITIONS OF SALE ST DISCLAIMS ANY EXPRESS OR IMPLIED WARRANTY WITH RESPECT TO THE USE AND/OR SALE OF ST PRODUCTS INCLUDING WITHOUT LIMITATION IMPLIED WARRANTIES OF MERCHANTABILITY, FITNESS FOR A PARTICULAR PURPOSE (AND THEIR EQUIVALENTS UNDER THE LAWS OF ANY JURISDICTION), OR INFRINGEMENT OF ANY PATENT, COPYRIGHT OR OTHER INTELLECTUAL PROPERTY RIGHT.**

**UNLESS EXPRESSLY APPROVED IN WRITING BY AN AUTHORIZED ST REPRESENTATIVE, ST PRODUCTS ARE NOT RECOMMENDED, AUTHORIZED OR WARRANTED FOR USE IN MILITARY, AIR CRAFT, SPACE, LIFE SAVING, OR LIFE SUSTAINING APPLICATIONS, NOR IN PRODUCTS OR SYSTEMS WHERE FAILURE OR MALFUNCTION MAY RESULT IN PERSONAL INJURY, DEATH, OR SEVERE PROPERTY OR ENVIRONMENTAL DAMAGE. ST PRODUCTS WHICH ARE NOT SPECIFIED AS "AUTOMOTIVE GRADE" MAY ONLY BE USED IN AUTOMOTIVE APPLICATIONS AT USER'S OWN RISK.**

Resale of ST products with provisions different from the statements and/or technical features set forth in this document shall immediately void any warranty granted by ST for the ST product or service described herein and shall not create or extend in any manner whatsoever, any liability of ST.

ST and the ST logo are trademarks or registered trademarks of ST in various countries.

Information in this document supersedes and replaces all information previously supplied.

The ST logo is a registered trademark of STMicroelectronics. All other names are the property of their respective owners.

© 2007 STMicroelectronics - All rights reserved

STMicroelectronics group of companies

Australia - Belgium - Brazil - Canada - China - Czech Republic - Finland - France - Germany - Hong Kong - India - Israel - Italy - Japan - Malaysia - Malta - Morocco - Singapore - Spain - Sweden - Switzerland - United Kingdom - United States of America

[www.st.com](http://www.st.com)



# Mouser Electronics

Authorized Distributor

Click to View Pricing, Inventory, Delivery & Lifecycle Information:

[STMicroelectronics:](#)

[STP75NF75](#) [STP75NF75FP](#) [STB75NF75T4](#)